

# M6310 Featurephone User Guide





# Introduction



*The M6310 Featurephone is a practical and convenient way to use a wide range of business telephone features, including Call Forward, Conference Calling, and Speed Dial. The M6310 is equipped with automated 7 programmable feature keys to be programmed as either line keys or as feature keys. It has also a two line display to show you information about your calls and a built in handsfree microphone.*

*This guide first takes you through the basic features of the M6310 telephone. You'll learn the different parts of the set and what they do, as well as other basics such as how to make calls and put calls on hold.*

*After you have covered the basics, you can then read how to set up the local features available on the M6310 telephone. Local features provide you with convenient ways to customize the set for your use.*

*The remaining portions of the guide describe Network features which can be installed on your M6310, such as Call Forward and Call Waiting. Unlike local features, Network features must be ordered from your telephone service provider. Note that some of the Network features contained in this guide may not be available to you. Also note that your service provider may have provisioned your set with features which are not described here. Contact your System Administrator or Customer Service Representative if you need more information or help with the Network features installed on your set.*

---

# Table of Contents



<b>Using your M6310 telephone—the basics</b>	<b>4</b>
Answering calls	6
Making calls	6
Placing a call on hold	6
Ending a call	7
Setting the alerter volume	7
Setting the handset volume	7
Setting the Handsfree speaker volume	7
Setting the On-hook monitor volume	7
Muting the handset	7
Tones that you hear when using the M6310	8
Handsfree Calling	8
Display Features	9
<b>Setting up local features</b>	<b>10</b>
Save, Memory, and Pause	10
Alerter Volume	11
Time and Date	12
Call Timer	12
Display Language	13
C.O. (Network) Features	13
Predial	14
Save Number	14
Memory Number	15
Pause	15
<b>Quick ways to make calls</b>	<b>16</b>
Automatic Dial	16
Automatic Line	16
Intercom	17
Intercom Group	17
Last Number Redial	18
Speed Call	18
<b>How to avoid missing a call</b>	<b>19</b>
Call Forward	19
Call Waiting	19
Call Pickup	20
Message Waiting	20

<b>When you can't reach someone</b>	<b>21</b>
Leave Message	21
Override	21
Ring Again	22
<b>Ways to transfer or share calls</b>	<b>23</b>
Conference	23
Call Park	24
Privacy Release	24
Transfer	25
<b>Controlling your telephone line</b>	<b>26</b>
Make Busy	26
Privacy	26
<b>Connecting your M6310</b>	<b>27</b>

# Using Your M6310 telephone—the basics



- 1. Handset** allows two-way communication while a call is established.
- 2. Speaker** turns on when you press an available line key. You can hear when the other party answers and pick up the handset to speak. You can also use the speaker to listen to the other party on Handsfree calls.
- 3. Release key** cancels active calls.
- 4. Hold key** keeps a caller on the line.
- 5. Feature/line keys** let you make and receive telephone calls or use installed features.
- 6. Prime Directory Number (PDN) key** is your main telephone line or extension number. It is automatically selected for outgoing calls when you lift the handset. Other telephone extensions that appear on your M6310 can be used by pressing the appropriate key.
- 7. Feature/Line Indicators.** The ► indicators appear beside active lines or features. A steady ► means that the feature or line is active. A slow flashing ► means the line is ringing. A fast flashing ► means the line is on hold or a feature is being programmed.
- 8. Dial Pad** gives you easy push-button dialing and programming.
- 9. Volume Key** adjusts the speaker, ringer, or handset volume. It is also used to scroll through setup functions shown on the display and to edit Predial digits.
- 10. Display** shows useful information about your calls or features
- 11. Alerter** flashes when the telephone rings
- 12. Handsfree** allows you to speak to a caller without using a handset (see handsfree calling page 8).
- 13. Mute** can be used to prevent the other party hearing you over handset/handsfree.

## Using Your M6310 telephone—the basics

### Answering calls

To signal an incoming call, your telephone rings, the alerter light flashes, and the indicator beside a line or intercom key flashes slowly.

#### *To answer a call:*

1. If the call is ringing on a line other than your PDN, press the line or intercom key beside the flashing indicator.
2. Lift the handset to speak or press  to answer the call (see page 8).

#### *To answer a call when the handset is off-hook and the line is not on:*

1. The incoming call is signalled by a lone alerter beep and a flashing indicator beside the line key. To answer the call, press the line key.

### Making calls

#### *Using your handset:*

1. Lift the handset—the PDN key is selected automatically and you hear a dial tone.
2. Dial the number.

#### *Using a line key:*

1. Press any available line key. You hear a dial tone from the speaker.
2. Dial the number.
3. Lift the handset when the other party answers or press  (Hands-free Mode only) to talk to the called party (see page 8).

### Placing a call on hold

#### *Using the Hold key:*

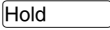
1. Press . The indicator flashes beside the line on hold and you can use other lines or features.
2. Press the line key with the flashing indicator to return to the held call.

#### *Using Automatic hold:*

1. Press another line key. The indicator flashes beside the line on hold and you can use other lines or features.
2. Press the line key with the flashing indicator to return to the held call.



## The basics: continued

### Ending a call

1. Hang up or press .



### Setting the alerter volume

1. Press  up or down while the telephone is ringing. The display shows the adjusted alerter (ringing) volume level, which remains in effect until the next adjustment.

### Setting the handset volume

1. Press  up or down while using the handset on a call. The display shows the adjusted handset volume level, which remains in effect until the next adjustment.

### Setting the Handsfree speaker volume

1. Press .
2. Press  up or down to adjust the volume. The display shows the adjusted Handsfree speaker volume level, which remains in effect until the next adjustment.

### Setting the On-hook monitoring volume

1. Press any available line key.
2. Press  up or down to adjust the volume. The display shows the adjusted monitoring speaker volume level, which remains in effect until the next adjustment.

### Muting the handset

The  button can be used to prevent the other party from hearing you over the handset. This is useful when you wish to speak privately with someone at your desk. When mute is active the handsfree lamp will flash.

#### *To mute your handset:*

1. Press .
2. Press again to release.

## The basics: continued



### Tones you hear when using the M6310

Dial tone	A continuous tone which means you can dial your call.
Busy tone	A tone which repeats once per second to indicate that the number you dialed is busy.
Reorder tone	A fast busy tone which indicates the call cannot proceed.
Confirmation tone	Two short beeps followed by silence informs you that the feature you used was successfully completed.
Call Waiting tone	Two short beeps sent at regular intervals which indicate a second incoming call.
Ring Again tone	One long and two short <i>pings</i> indicate that the line for which you left a Ring Again request has come free.
Special tone	Three beeps followed by a dial tone indicate that you can proceed with the feature you have activated



### Handsfree Calling

The Handsfree feature allows you to use the built-in microphone and speaker on your M6310 to carry on a telephone conversation. While using Handsfree, speak clearly and face the M6310 — raise your voice a little if you move away from the telephone. You can also use the Mute feature to turn off your microphone. Mute is useful when background noises interfere with your conversation or when you want to speak privately with someone at your desk.



#### *To answer a call using Handsfree:*

1. Press  instead of picking up the receiver.
2. If you wish to speak privately with the other person, pick up the handset. Handsfree turns off automatically.
3. Press  to end your call.

#### *To use Handsfree during your call:*

1. Press  and replace the handset in the cradle.
2. To speak privately once again, pick up the handset.
3. Press  to end your call.

#### *To mute your microphone while on a Handsfree call:*

1. Press .
2. To turn your microphone on again, press  once more.

### Display features

The M6310 has an adjustable two-line display which shows you helpful information about the features you activate or the calls you make and receive. When making an outgoing call, for instance, the numbers you dial are shown on the display.

If your organization has installed the Calling Name Display feature, your display shows an incoming caller's name and telephone number:

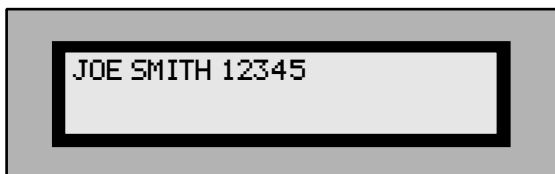

If your organization has the Reason Display feature, your display shows additional information. For example, when you have forwarded an incoming call to another telephone in your system your display shows the following information:



The top line of the display shows the name and number of the person receiving the forwarded call. The bottom line shows your name and number as well the name of the feature which has been activated.

The messages and names which are shown on your display are selected by your organization and may differ from those shown above. Check with your System Administrator or Customer Service Representative to find out the messages and names you can expect to see.

## Setting up local features

The M6310 has a variety of local features which you can set up to make the set easier to use and to customize the set to meet your specific needs. The **PROGRAM** key allows you to enter Programming mode to set up the following features:

- Alerter Volume
- Time and Date Set
- Time and Date Format
- Call Timer
- Display Language
- C.O. (Network) Features
- Predial
- Memory Number

### Save, Memory, and Pause

The following three additional feature keys are available, when the C.O. (Network) Features function is disabled:

- Save Number
- Memory Number
- Pause

Note: when C.O. (Network) features are disabled the M6310 is set up to have the Save Number, Memory Number, and Pause keys available to you and they appear at the feature key locations shown below:

▶	<b>PROGRAM</b>	Feature key 8
▶	Save	Feature key 7
▶	Memory	Feature key 6
▶	Pause	Feature key 5
▶		Feature key 4
▶		Feature key 3
▶		Feature key 2
▶		PDN key (Feature key 1)

## Setting up local features: continued

### Save, Memory, and Pause (continued)

These keys are always available to you unless C.O. (Network) Features are enabled. C.O. (Network) Features must be enabled when the Save Number, Memory Number, and Pause keys are provisioned for switch features by your service provider). To find out whether the C.O. (Network) Features should be disabled or enabled, contact your System Administrator or Customer Service Representative.

The Save Number, Memory Number, and Predial functions are not available when the set is used in the Automatic Call Distribution (ACD) environment. These three local features only work with the Prime Directory Number (PDN) of the set.

Note that an incoming call interrupts the activation or programming of all local functions. Local features are also not available during an active call, with a call on hold, or when a C.O. (Network) feature is active (the **Time/Date** C.O. (Network) feature is active for 12 seconds).

### Alerter Volume

*To adjust the alerter volume:*

1. Press **PROGRAM**.
2. Press **◀▶** until **Alerter Volume?** is shown on the display.
3. Press **Hold**.
4. Press **◀▶** to adjust the volume level. The bars on the display indicate the adjusted level.
5. Press **Hold** to save the new alerter volume level.
6. Press **PROGRAM** or **Rls** to exit programming mode.

## Setting up local features: continued

### Time and Date

#### *To set the time and date on your M6310:*

1. Press **PROGRAM**.
2. Press **◀▶** until Time and Date Set? is shown on the display.
3. Press **Hold**.
4. Enter the date using the format shown on the display.
5. Enter the current time based upon the 24 hour clock.
6. Press **Hold** to save the new time and date settings.
7. Press **PROGRAM** or **Rls** to exit programming mode.

#### *To select the time and date display format:*

1. Press **PROGRAM**.
2. Press **◀▶** until Time and Date Format? is shown on the display.
3. Press **Hold**.
4. Press **◀▶** until the desired format is shown on the display.
5. Press **Hold** to save the new format setting.
6. Press **PROGRAM** or **Rls** to exit programming mode.

### Call Timer

The Call Timer uses the display to show the time elapsed since the start of a normal call (the timer appears on the display 5 seconds after the call starts and remains on the display 5 seconds after you end the call). Follow the instructions below to enable the Call Timer.

#### *To enable the Call Timer:*

1. Press **PROGRAM**.
2. Press **◀▶** until Call Timer? is shown on the display.
3. Press **Hold**.
4. Press **◀▶** to enable or disable the Call Timer.
5. Press **Hold** to save the new setting.
6. Press **PROGRAM** or **Rls** to exit programming mode.

## Setting up local features: continued

### Display Language

*To select the language used to show information on the display:*

1. Press **PROGRAM**.
2. Press **◀▶** until Language? is shown on the display.
3. Press **Hold**.
4. Press **◀▶** until the desired language is shown on the display.
5. Press **Hold** to save the new setting.
6. Press **PROGRAM** or **Frls** to exit programming mode.

### C.O.(Network) Features

The M6310 allows you to replace the Save Number, Memory Number, and Pause local features with additional Central Office C.O. (Network) Features. When instructed to do so by your System Administrator or Customer Service Representative, use the following instructions to enable or disable Central Office C.O. (Network) Features. When enabled, the additional features will be located on the feature keys normally pressed to use Save Number, Memory Number, and Pause.

*To enable/disable C.O. (Network) Features in place of the Save, Memory, and Pause keys:*

1. Press **PROGRAM**.
2. Press **◀▶** until C.O. Features? is shown on the display.
3. Press **Hold**.
4. Press **◀▶** until the desired setting is shown.
5. Press **Hold** to save the new setting.
6. Press **PROGRAM** or **Frls** to exit programming mode.







*Note: If your phone has network features programmed on Feature Keys 7, 8 & 9 please ensure that **C.O. Features** is **ENABLED**.*

## The basics: continued

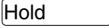

### Predial

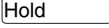
The Predial feature allows you to dial your number first, inspect it as it is shown on the display, and then pickup the handset or press  to make your call.

#### *To enable/disable the Predial feature:*

1. Press .
2. Press   until Predial? is shown on the display.
3. Press .
4. Press   to enable or disable the Predial feature.
5. Press  to save the new setting.
6. Press  or  to exit programming mode.

#### *To make a call when Predial has been enabled:*

1. Dial the telephone number — the number is shown on the display.
2. Pickup the handset or press . The M6310 selects the PDN line and makes the call. Note that you can edit the Predial number by using the   key and the dialpad digits.



### Save Number

The Save Number feature allows you to save the telephone number you are calling so that you can redial the number quickly the next time you call.

#### *To save the number for the current call:*

1. Before you end the current call, press . When the number has been saved, Saved is displayed on the top line of the display for 3 seconds.

#### *To make a call using the number you saved:*

1. Press .
2. Pickup the handset or press . The previously saved number is dialed automatically. Note that the number remains unchanged until you save another number.



## Setting up local features: continued

### Memory Number

The Memory Number feature allows you to program up to five telephone numbers which can be recalled and dialed quickly and easily. Note that the **Memory?** option does not appear on the Program menu when C.O. (Network) Features are enabled.

#### *To program a number into memory:*

1. Press **PROGRAM**.
2. Press **◀▶** until **Memory?** is shown on the display.
3. Press **Hold**.
4. Press **◀▶** until the desired memory location is shown on the display (**M1**, **M2**, **M3**, **M4** or **M5**). (If a number has already been stored, it is also shown on the display).
5. Enter the number you wish to store.
6. Press **Hold** to save the new setting.
7. Press **PROGRAM** or **F1s** to exit programming mode.

#### *To make a call using Memory Number:*

1. Press **Memory** until the stored number you wish to call is shown on the display (**M1**, **M2**, **M3**, **M4** or **M5**).
2. Pickup the handset or press **📞**.

### Pause

In order to make certain types of calls, you are sometimes required to pause a moment during dialing. When storing this type of telephone number using Memory Number or Speed Call, the required pause can be inserted into the sequence of digits (or *dial string*) by using the Pause key.

#### *To insert a pause into the dial string:*

1. Press **Pause** at the appropriate place when entering the number. For example, to enter a pause when accessing voice mail, the sample dial string shown below can be entered:

**8 0 8 8** **Pause** **4 3 2 1 #**

## Quick ways to make calls

The remaining sections of the guide describe network features which can be installed on your M6310. **Note that some of the network features contained here may not be available to you. Also note that your service provider may have provisioned your set with network features which are not described here.**

### Automatic Dial

Use Automatic Dial to program feature keys on your telephone for one-touch dialing. Automatic Dial keys on your set are assigned by your Customer Service Representative or System Administrator.

#### *To program an Automatic Dial key:*

1. Press the Automatic Dial key you want to program.
2. Dial the number you want to store.
3. Press the Automatic Dial key again.
4. Label the key. You may want to use a name or telephone number to identify the key.

#### *To erase an Automatic Dial key:*

1. Press the Automatic Dial key you want to clear.
2. Press **#**.
3. Press the Automatic Dial key again.

#### *To make a call using an Automatic Dial key:*

1. Lift the handset. (You can also press the desired key,  to start the call).
2. Press the desired Automatic Dial key to dial the number you want to call.

### Automatic Line

Automatic Line keys are pre-programmed for you by your Customer Service Representative or System Administrator to dial a specific number. You should label any installed Automatic Line keys with a name or number.

#### *To use an Automatic Line key:*

1. Press the desired Automatic Line key.
2. Lift the handset or press  when your party answers.

## Quick ways to make calls: continued

### Intercom

An Intercom Key is programmed by your Customer Service Representative or System Administrator to call a specific telephone in your system.

#### *To place an Intercom call:*

1. Press .
2. Lift your handset or press  when the other party answers. If the person does not answer the call within two seconds, their telephone automatically answers through the speaker.

### Intercom Group

Telephones in your system can be organized in Intercom Groups based upon projects or departments. Each telephone in the group is then assigned an Intercom group number. See your Customer Service Representative or System Administrator for more information.

#### *To call someone in your Intercom Group:*

1. Press .
2. Dial the intercom number assigned to the person you want to call.
3. Lift your handset or press  when the other party answers.

#### *To answering an Intercom Group call:*

1. Press  when the indicator is flashing.
2. Lift your handset or press .

## Quick ways to make calls: continued

### Last Number Redial

You can redial the **last** number you called on a specific line. This is useful if the number you called was busy and you want to reach the person again.

#### *To call using Last Number Redial:*

1. Press the line key used to make the last call.
2. Press **#** twice.
3. Lift the handset when the other party answers.

### Speed Call

You can dial telephone numbers quickly and easily using one- or two-digit codes. Speed Call provides you with 10 one-digit codes (0–9) or up to 70 two-digit codes (00–69). See your Customer Service Representative or System Administrator to find out which type of codes are available to you.

#### *To program a Speed Call number:*

1. Press **[Spd Call]**.
2. Enter a one- or two-digit code (0–9 or 00–69).
3. Dial the telephone number you want to assign to that code. You can store telephone numbers up to 24 digits long. Note that if there is a number already assigned to this code, the new number you input erases the old.
4. Press **[Spd Call]** again.
5. Make a note of the Speed Call code and telephone number for future reference.

#### *To erase a programmed Speed Call number:*

1. Press **[Spd Call]**.
2. Enter the one- or two-digit code for the number you want to erase.
3. Press **#**.
4. Press **[Spd Call]** again.

#### *To make a call using Speed Call:*

1. Lift the handset. (You can also press the desired line key, **[Speaker]** to start the call).
2. Press **[Spd Call]**.
3. Dial the code for the telephone number you want to call.

# How to avoid missing a call

## Call Forward

Away from your telephone, but expecting an important call? Do you want someone to take your calls for you while on vacation? Call Forward lets you redirect your calls to another telephone or voice message system.

### *To set Call Forward:*

1. Press .  
The indicator beside the Call Forward key flashes.
2. Enter the number to which you want to redirect your calls or skip to step 3 if you want to use the previous Call Forward number.
3. Press  again.  
The indicator beside the Call Forward key goes ON.

### *To cancel Call Forward:*

1. Press .  
The indicator beside the Call Forward key goes OFF.

## Call Waiting

Call Waiting lets you know when you have a second incoming call by sending two short tones to the handset or speaker at regular intervals and by lighting the Call Waiting indicator.

### *To answer your second call:*

1. Press the  key which shows the flashing indicator.  
The original call goes on hold automatically.

### *To return to your original call:*

1. Press the line key of the original call. The other party is put on hold automatically and the  indicator winks. You can alternate between the calls by pressing the appropriate line key.

## How to avoid missing a call: continued

### Call Pickup

Telephones in your system can be programmed by your Customer Service Representative or System Administrator into Call Pickup groups. Call Pickup lets you answer a call ringing at any telephone in your pickup group from your M6310.

#### *To pickup a call ringing at another telephone in your pickup group:*

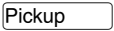
1. Lift the handset. (You can also press the desired line key,  to start the call).
2. Press .

### Message Waiting

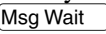
Message Waiting for the M6310 works with the Leave Message feature or with your organization's voice mail system. An indicator beside the  key is ON whenever someone has left you a call request or a voice mail message. Message Waiting queues up all call requests left for you starting with the first caller.

#### *To retrieve your messages:*

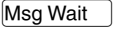
1. Lift your handset or press .
2. Press  to dial the Message Center automatically or dial the Message Center number yourself.
3. Retrieve your messages one by one until all messages have been heard. The Message Waiting indicator turns OFF when you have listened to all of your messages.

# When you can't reach someone

## Leave Message

Leave Message work with the Message Waiting feature by letting you send a call request to another telephone in your system. Your call request allows the other party to return your call quickly and easily.

### *To leave a call request:*

1. Make a call.
2. If there is no answer or the line is busy, press  .  
The Message Waiting indicator on their telephone goes ON.

## Override

Override lets you interrupt a person on a call. It is helpful in emergency situations or when someone expects you to call with important news.

### *To bridge into a two-way call within your system:*

1. Press  when you hear a busy signal.
2. To temporarily disconnect the third party and speak privately with the person you called, press  again.
3. To allow the original parties to carry on with their conversation, hang up your telephone.

*Note: Not all lines in your system can be overridden when busy — check with your Customer Service Representative or System Administrator. When you cannot interrupt a call, you hear a reorder tone.*

### Ring again

When you receive a busy signal when calling someone, Ring Again can signal you when their telephone becomes free. You can then use Ring Again to automatically redial the number. Note that you can only have one Ring Again request at a time.

#### *To use Ring Again:*

1. Make a call.
2. If the line is busy, press **Ring Again**.
3. Press **Rls** to release the call. When the telephone you called becomes free, you hear a Confirmation tone from the speaker and the Ring Again indicator flashes.
4. Lift the handset or press **End Call**.
5. Press **Ring Again** to automatically redial the number. If you do not press **Ring Again** within a pre-defined time limit (between 8–32 seconds), the Ring Again request is cancelled automatically.
6. If you have only one line and are already on a call when the Ring Again indicator flashes, you must complete the call before the pre-defined time limit and press **Ring Again** to redial the previously busy number.

If you have two lines and are already on another call when the Ring Again indicator flashes, press **Hold** to put the current call on hold. Press the free line key and then press **Ring Again** to redial the number.

#### *To cancel a Ring Again request:*

1. Press **Ring Again** before you hear the Ring Again Confirmation tone.



# Ways to transfer or share calls

## Conference

You can set up a telephone call between you and up to five other people. This is useful when meeting in a common place is not possible.

### *To add a person to a call:*

1. While on the current call, press . The current call goes on hold automatically and you hear the dial tone.
2. Dial the number of the new person you want to add to your call.
3. Press  to establish a conference.  
The line key indicator for the new person goes OFF once added to the conference.
4. Repeat steps 1–3 until you have added all the desired parties to the conference.

### *To add an incoming call to the conference:*

1. While on the current conference call, press the line key of the incoming call. The conference call goes on hold automatically.
2. Press  to add the new caller.

### *To end the conference call:*

1. Hang up or press  .

*Note: Check with your Customer Service Representative or System Administrator to verify the number of people that can be added to your conference call.*

## Ways to transfer or share calls: continued

### Call Park

Call Park lets you put a call on hold at your telephone, then retrieve the call from any telephone in your system.

#### *To park a call:*

1. While on a call, press .  
You hear two short beeps followed by silence.
2. Hang up.

#### *To retrieve a parked call from any telephone in your system:*

1. Lift the handset.
2. Press .
3. Dial the number of the telephone that parked the call.

### Privacy Release

If you share a line with other people and the line is programmed for Privacy, no one can access the line while you are using it. You can temporarily release Privacy so that a co-worker can join your call.

#### *To temporarily release Privacy while on a call:*

1. Press . Your co-worker can now select the line and join the call.

#### *To make your call private again:*

1. Press .
- Privacy is also automatically restored to your line when you end your call.

## Ways to transfer or share calls: continued

### Transfer

Send a current call to another telephone within your system using Transfer. You can either remain on the line when you make the transfer or simply redirect the call.

#### *To transfer a call directly to another telephone:*

1. Press  or .
2. Call the person to whom you want to transfer the call. When the person answers, you can talk privately — the original caller cannot hear your conversation. If the line is busy or if the person does not answer, press  to return to the original caller.
3. Press  or  to complete the transfer and disconnect yourself from the call.

#### *To transfer a call by establishing a conference:*

1. While on the current call, press .
- The current call goes on hold automatically. You hear three beeps followed by the dial tone.
2. Dial the number of the new person you want to add to the conference. When the person answers, you can talk privately — the original caller cannot hear your conversation. If the line is busy or the person does not answer, press  to return to the original caller.
3. Press  to establish a conference. You can now speak with both parties.
4. Press  to disconnect yourself from the call and complete the transfer.

# Controlling your telephone line

## Make Busy

You can make your telephone appear busy to all callers except those using the intercom. You might want to use this feature when you are meeting with someone and don't want to be disturbed.

### *To make your telephone appear busy:*

1. Press . The indicator beside the Make Busy key goes ON.

### *To cancel Make Busy:*

1. Press  again. The indicator beside the Make Busy key goes OFF.

## Privacy

If you share a line with other people and the line is not programmed for Privacy, anyone can access the line while you are using it. Privacy lets you make a call temporarily private.

### *To make your current call private:*

1. Press .
- Other people who share your line are now prevented from bridging into your call.

### *To remove the privacy status from your call:*

1. Press  again.
- Privacy is also automatically removed from your line when you end your call.

# Connecting your M6310

If your M6310 has not been connected to the wall jack/power supply or you are moving the set to another location, use these instructions to make all the required connections.

*To connect your M6310 to the telephone wall jack and AC power:*

1. Use the silver-grey line cord (7.5 feet/2.25 meters) and the AC adapter unit provided with your M6310. Contact your System Administrator or Customer Service Representative if you need a replacement for a missing or damaged adapter.
2. Remove the stand F.
3. Insert one end of the line cord into the appropriate jack (A) located underneath the M6310. The connector clicks into place when correctly inserted.
4. If the handset has not been connected, insert one end of the curly handset cord into the appropriate jack (C). Feed the cord through the restraining tab (D) so that the cord falls to the left side of the set. Insert the other end of the handset cord into the handset.

**Figure 1 – M6310 connections**

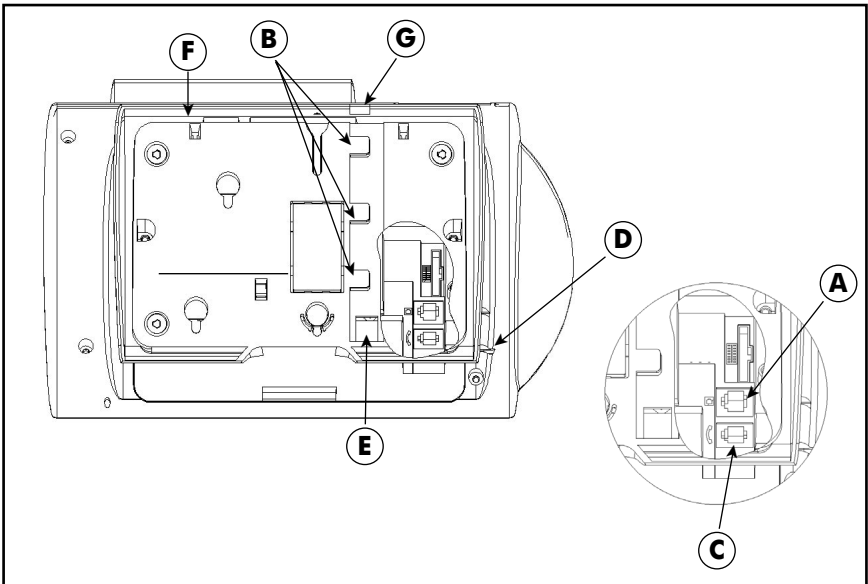

## Connecting your M6310: continued

5. Run the free end of the line cord through the “E” hole in the plinth “F”. Slide the cord under the retaining tabs “B” (allow a little slack). Refit the stand in high or low position.
6. Turn the M6320 right-side up and position it on your desk, ensuring that line cord runs through slot “G”.
7. Insert the free end of the line cord into the open jack (Z) on the plastic connector (Y) – see Figure 1.
8. Insert the free end of the plastic connector (X) into the wall jack (W) – see Figure 1.
9. Plug in the AC adaptor (V) into a AC 110V wall socket (U).

**Figure 2 – U.K. Wall jack/AC adaptor connections**

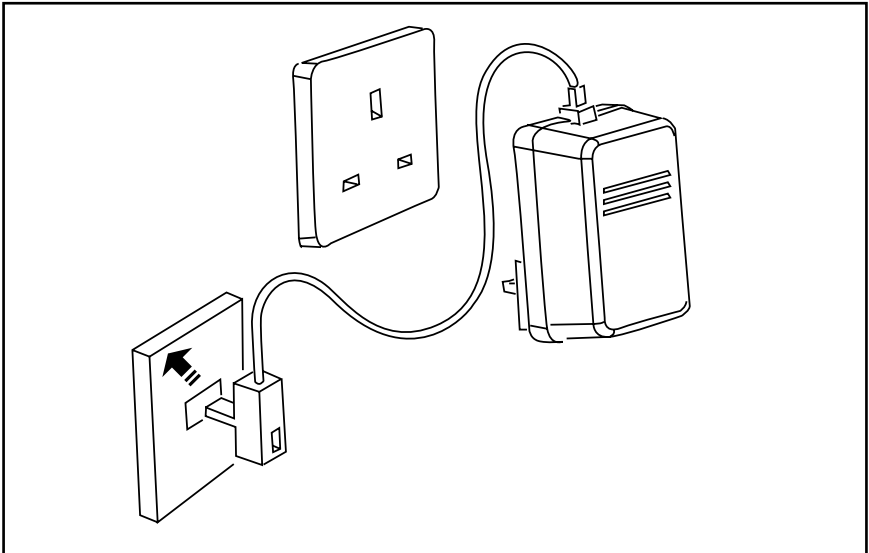

**Figure 2 – European Wall jack/AC adaptor connections**

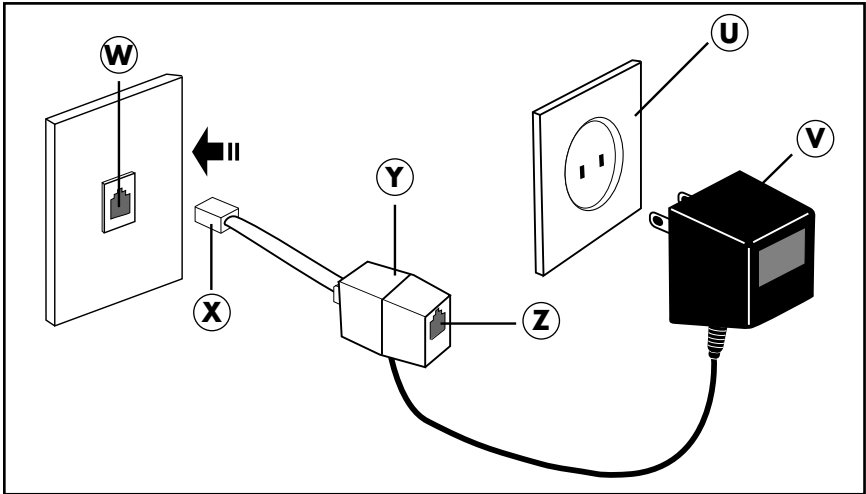

## Approval Requirements

### Permitted Connections

*This telephone, with its associated power supply connector, may only be connected to a Centrex telephone system using a socket provided by your system administrator.*

*Only one terminal with its associated power supply may be connected to the telephone socket.*

### Non-permitted Connections

*This telephone must not be connected to the Public Switched Telephone Network.*

### Power Failure

*In the event of a local power failure, calls can be made using the handset, incoming ringing may be at a reduced level and special features such as the display and handsfree operation will not function.*

## Safety Requirements

### Power Supply

*The telephone must be installed near an electrical outlet which should be easily accessible.*

### Caution Hazardous Voltages

*When the terminal is connected to the telephone network all of the interconnection points are at Telephone Network Voltage (TNV).*

*The telephone and any accessories must be assembled and connected in accordance with the manufacturer's instructions in the user guide before the equipment is plugged into the telephone line socket.*

### CE Marking

**CE** This equipment complies with the requirements of the EMC Directive 89/336/EEC for Electromagnetic Compatibility and the LVD Directive 72/23/EEC for Electrical Safety as amended by Directive 93/68/EEC.

**Copyright © Aastra Technologies 2004.  
All rights reserved**

Information is subject to change since Aastra Technologies reserves the right, without notice, to make changes in equipment design or components as progress in engineering or manufacturing methods may warrant.

**P0870911**

**ISSUE 04**

**A/STRA**  
Telecom